

EDGEGLIDE⁺
INLINE SLIDING DOOR

Patio Door

Installation Guide

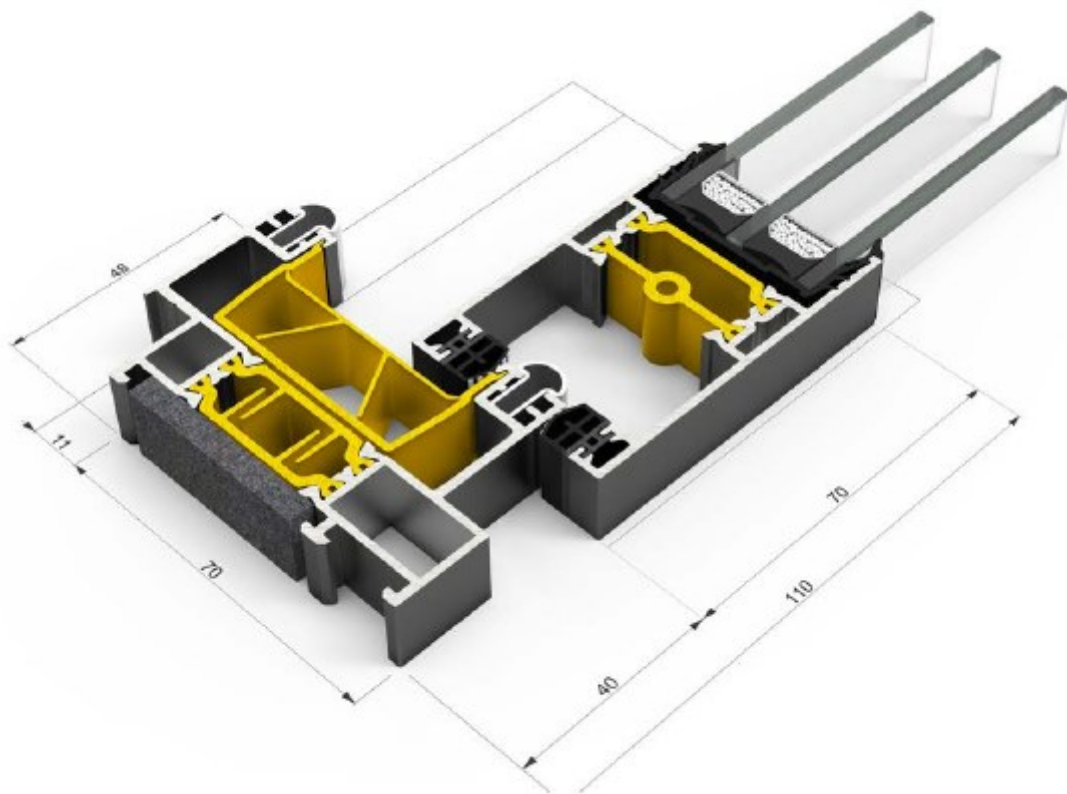

INDEX

GENERAL INSTALLATION INSTRUCTIONS.....1

RECOMMENDED TOOL LIST.....2

PARTS LIST.....3

1. SITE SURVEY.....4

 a. Structural Opening inspection.....4

 b. Internal FFL and datum line position.....4

 c. Height inspection using datum line.....5

 d. Jamb inspection.....5

 e. Manufacturing sizes.....5

2. DRAINAGE DETAILING.....6

 a. Cill Installation.....6

 b. Duo track drainage7

 c. Triple track drainage.8

3. FRAME ASSEMBLY AND INSTALLATION.....9

 a. Outer frame assembly.....9

 b. Drainage hole location.....10

 c. Outer Frame Installation.....10/11

 d. Frame fixings.....11

4. DOOR SASH INSTALLATION.....12

 a. Insert and adjust Sashes.....12/13/14

 b. Sash end caps.....14

 c. Sash buffers.....15

 d. Lock keeps and Anti-lift16/17/18

 e. Door stop18

 f. Drainage covers.....19

7. FINISHING TOUCHES.....20

8. OPERATION AND MAINTENANCE.....20

 a. Opening and closing operation for minimal sliding doors.....20

 b. Maintenance recommendations.....20

PLEASE READ ENTIRE MANUAL BEFORE STARTING WORK.

GENERAL INSTALLATION INSTRUCTION

ASSEMBLY INSTRUCTIONS

IMPORTANT. Read these assembly instructions before beginning any installation work. Install as recommended otherwise the door unit may not function properly and any warranty, written or implied, will be void.

QUALIFICATIONS

The assembly instructions are only for the attention of qualified installers who are trained and qualified in window and doors installation techniques, and are aware of the manufacturer's recommendations for the system used.

TRANSPORT AND STORAGE

Parts that could come lose during transportation can be damaged or cause accidents.

All packaging should be opened to allow the goods to be inspected must be closed and properly sealed for further transport.

Any goods that will be further transported must be loaded safely and securely.

INCOMING GOODS

All goods received must be inspected for any transport damage prior to being removed from the vehicle. The goods received must match the delivery note.

Any wet packaging may cause damage to the goods, and therefore must be removed immediately.

SITE SURVEY

It is important to check the conditions on site before starting the assembly.

- Check for any apparent defects and deficiencies around the structural opening. If any defects are found, then the customer must be notified, and agreement reached as to who is responsible for rectifying these defects prior to the new window/door installation.
- Check structural conditions such as the wall construction, the load capacity or adhesiveness of the edges for adhesive sealing systems, evenness, building moisture, a possibility for load transfer and mounting, constructional tolerances and height reference points.
- Check for contractual agreements, supplied assembly detail, planning guidelines, heat protection, humidity proofing, and interferences to other assembly sections.

ATTENTION! The fixing materials are not part of the scope of supply. The installer must decide on which fixing materials to use after assessing the given substructure. If any supplied fixing materials are used. The installer must ensure that the fixing materials are suitable for the respective substructure and that assembly is completed correctly.

HANDOVER

All operating, assembly and adjustment instructions as well as maintenance and care guidelines must be delivered to the user when briefing them. It is essential to train the user on the function of the supplied product and provide instruction on the directions for safety and use. Incorrect operation or failure to observe the instructions may lead to damage and accidents. The customer must store the instructions carefully and hand them over to the new owner in the event of sale.

RECOMMENDED TOOLS

- Appropriate fixings into structural opening.
- Mixed selection of frame packers.
- Mixed selection of glazing packers.
- Rubber mallet or plastic mallet
- Set of HSS drill bits.
- Drill / SDS hammer drill.
- Saw for cutting aluminium sill.
- Long spirit level
- String line
- Laser Level
- Tape measure
- No.2 Pozi drive
- 2.5mm; 3mm; 4mm ,5mm Allen keys.
- Gloves
- Vacuum Cups
- Paper Towels
- Utility Knife
- Low modulus Silicone and applicator gun
- Sealing Washers (e.g. EPDM Bonded Washers)
- Set Square.
- Trestle Tables x4

Before starting ensure you have all required accessories and supplies

Profile:

- Outer Frame profile with plastic insert
- Glazed Sash
- Cill and end caps (If required)

- Keeps

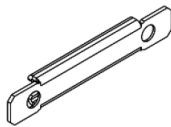

- Handle

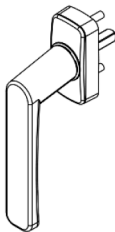

- Sash buffers

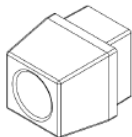

- Fixation kit



- Fixation kit

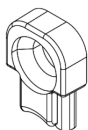

Accessories and Hardware:

- Locks (In sash)

- Drip bar end cap

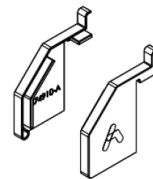

- Drainage caps

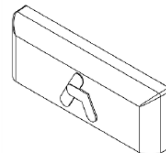

- Door stop

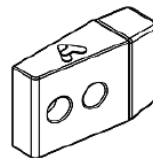

- Corner Cleat

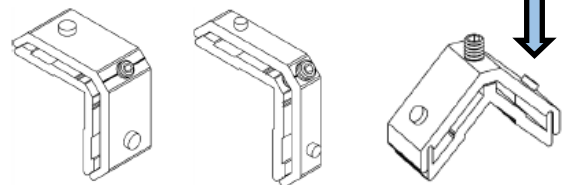

(For 3 track only)

- Alignment chevron

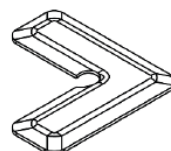

1. SITE SURVEY

a. Opening inspection

- The aperture for the new doors must be flat, level, straight, plumb and square at every single side. There should be a solid structure to fix the frame.
- The aperture load bearings must not be transferred to any part of the frame when fitted.
- Prepare the aperture by making sure it is clean.
- Remove any old silicone and brush down the threshold.
- The internal and external reveal sizes should be checked and any variations taken into consideration.
- Check the aperture’s height, width and diagonals to ensure the opening is equal on all sides and square.
- Generally three measurements should be taken with the smallest used to determine manufacturing sizes.

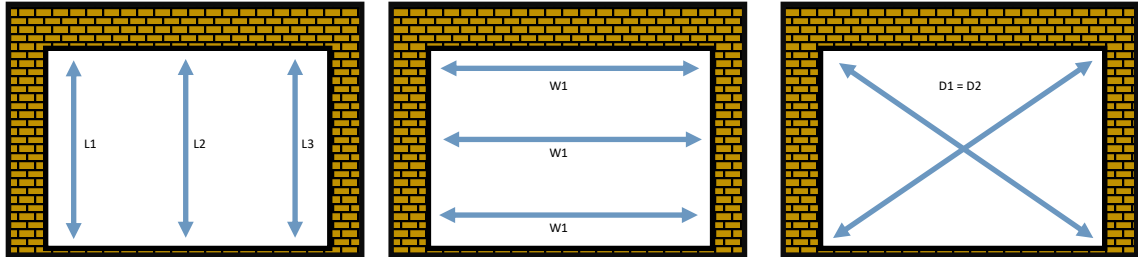

- Use tape measure to verify the aperture overall height and width. Rake at least three measurements.
- Smallest height and width measurement will determine the overall frame manufacturing size.
- Verify the aperture is square by measuring and comparing the diagonals.

b. Internal / external finished floor level and datum line position

- Select a point within the agreed/existing structure from where the builder can determine the internal finished floor level i.e. tiles, carpet, timber.
- Using laser level, set a datum line at 1000mm from the finished floor level.
- Mark the datum line on each jamb of the aperture.
- Use this datum line to aid in surveying to ensure the internal FFL aligns correctly against the bottom outerframe of the door – concealing it if desired.

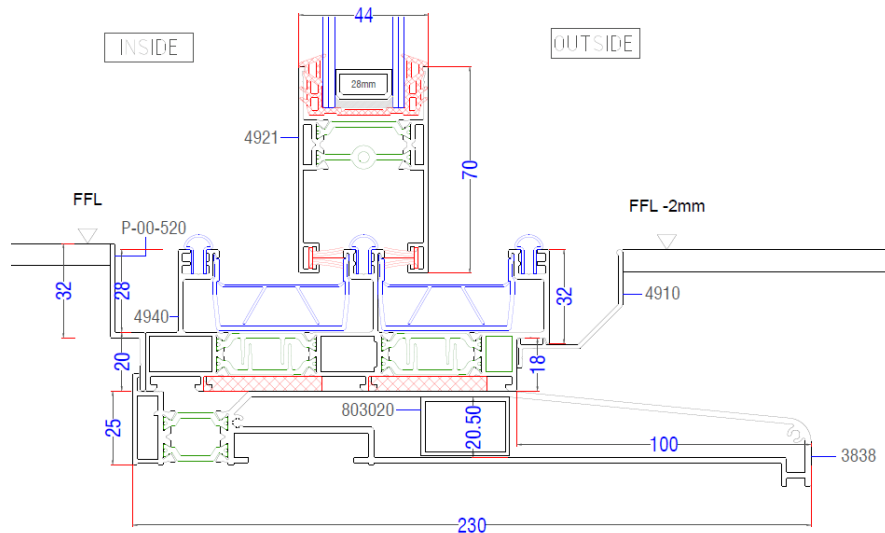

c. Aperture height inspection using datum line

- From the laser datum line measure the distance to the threshold at left, centre and right positions where new bi-fold door will sit on.
- Each of the bottom measurements should be uniform. If not then the threshold is not level and structure should be leveled.
- From the original datum line position (set at 1000mm) measure the distance to the top underside of the aperture at left, centre and right positions.
- Each of the top measurements should be uniform. If not then aperture at the top is not level and the adjustment to the manufacturing height of the frame must be made.

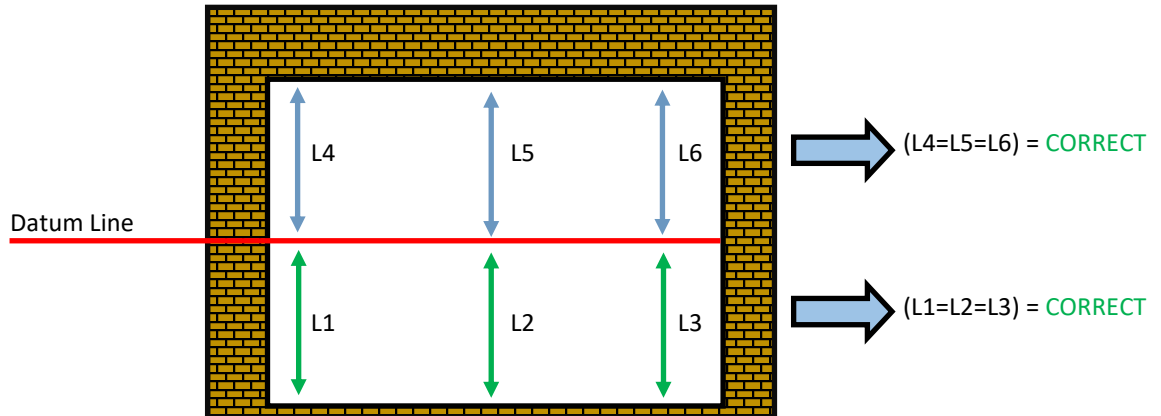

d. Jamb Inspection

- Set a vertical laser datum line position at 250mm from the jamb.
- Take measurements from top, middle and bottom of the laser line to the face of the jamb.
- Each horizontal measurements should be equal. If not, then the jamb is not plumb and adjustment to the manufacturing frame width must be made.
- Repeat jamb inspection for the opposing side.

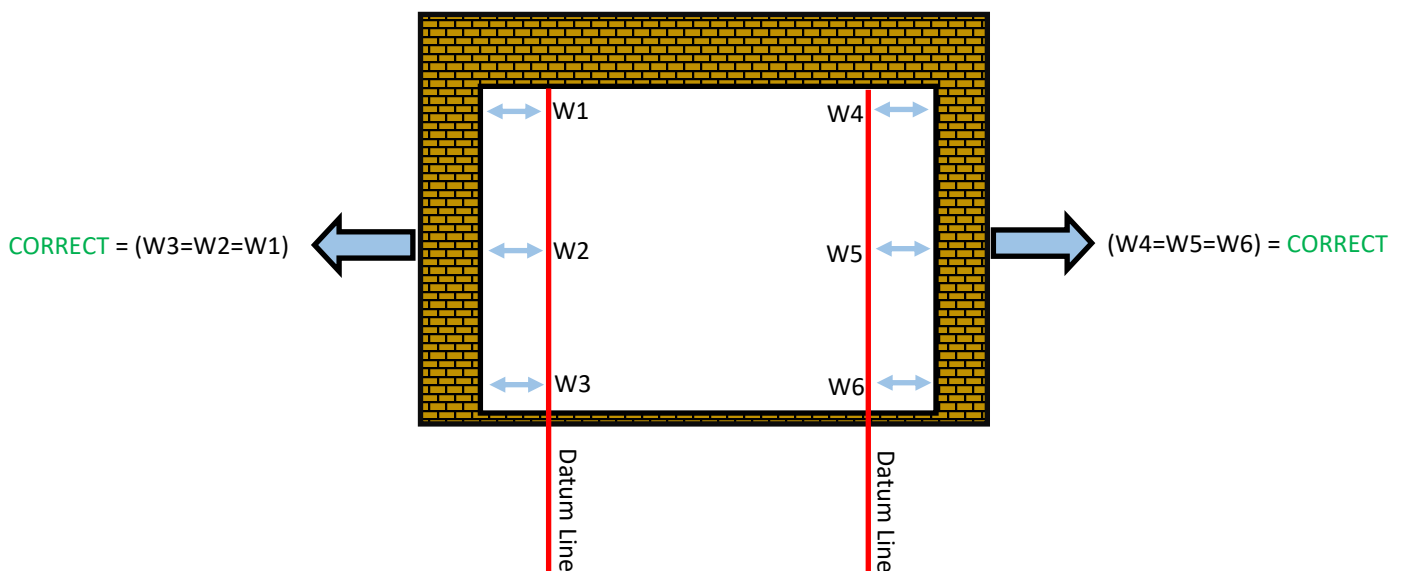

e. Manufacturing sizes

- Allow the aperture to be 10-15 mm wider and 10-15 mm higher than the overall frame size of the ordered unit. It is important that the opening size for new frame is correct.
- The height of the doors is measured from the bottom of the outer-frame and not from the finished floor.

2. DRAINAGE DETAILING

a. Sub-cill installation

- The type of drainage detail to be used should be determined and agreed with the builder at the beginning of the project.
- A sub-cill detail is typically used on a traditional brick or concrete upstand where there is a step down to the external floor level.
- A level threshold detail is used to produce a completely flush run-through of the internal and external floor finishes.
- All types of cill should be positioned to leave a minimum overhang of 25mm.
- The installer should determine how sub-cills should be fitted, taking into account features such as horns.
- Check the sub-cill for drainage slots, make sure they are clean and not blocked by any debris, clean if necessary.
- Using low modulus silicone seal the ends of the sill section and then install the end caps .

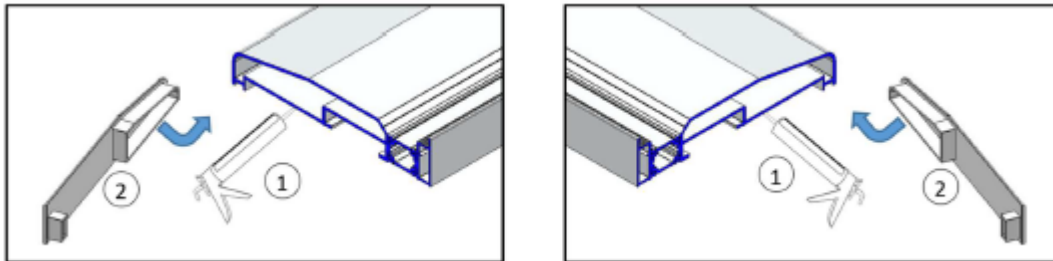

- Place the sub-sill on to the aperture.
- Use a spirit/laser level or a string line to assess the level of the sub-sill.
- Temporarily place the required packers under the sill, check the level and adjust if necessary

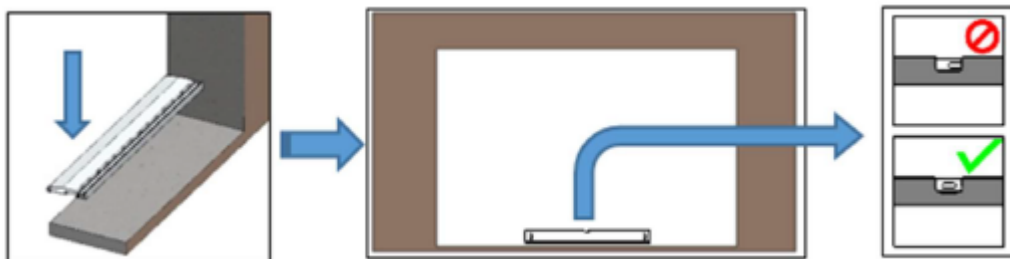

- Use specified fixings to fix the sill through the thermal break at minimum 150mm from each end, and spacing every 300mm centres.
- Fill each fixing hole with low modulus silicone before inserting the fixing.
- Double check for level and adjust if necessary.
- Apply a continuous line of low modulus silicone

3. FRAME ASSEMBLY AND INSTALLATION

a. Outer frame assembly

- Before assembling the frame, remove the highlighted cover cap. This can be easily clipped back in. When removing it, you need to remember exactly where it needs to go back otherwise gaps will form in the corners.

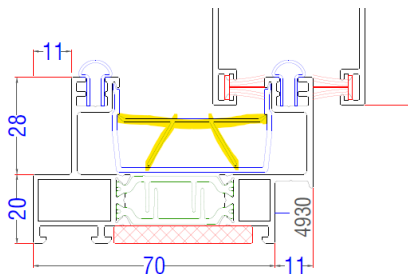

- Apply low modulus silicone at all outer frame connection joints and between the frame components.
- Insert the corner cleats on one side of the frame and slide the other side into the cleat. 2 track systems have 2 cleats per corner and 3 track system have 3 cleats per corner.

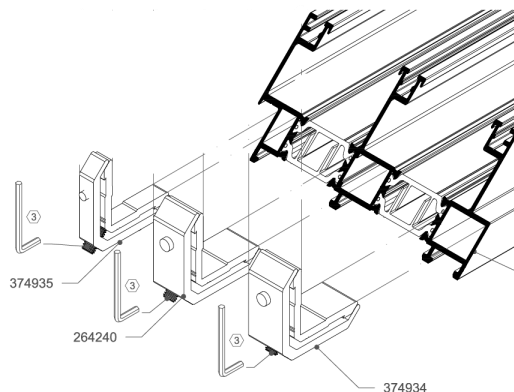
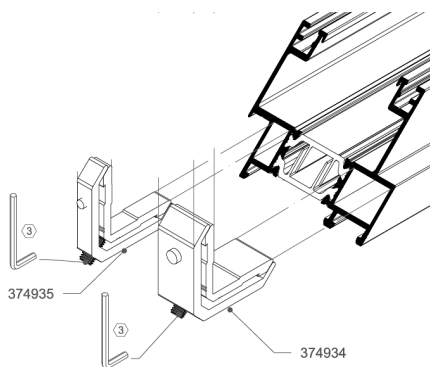

- Align the frame and use an Allen key to mechanically fix the cleats into place. Any silicone excess should be wiped off at this stage.
- Repeat same process to all four outer frame corners.



c. Outer frame installation

- Insert the frame into prepared structural opening ensuring the drainage holes face the outside of the reveal. Pack as necessary to ensure that the frame is held plumb and square inside the opening.
- Run a silicone bead along the sub-sill rebate and any other areas requiring a water seal indicated on the relevant drainage detail to ensure the juncture is weather-tight.

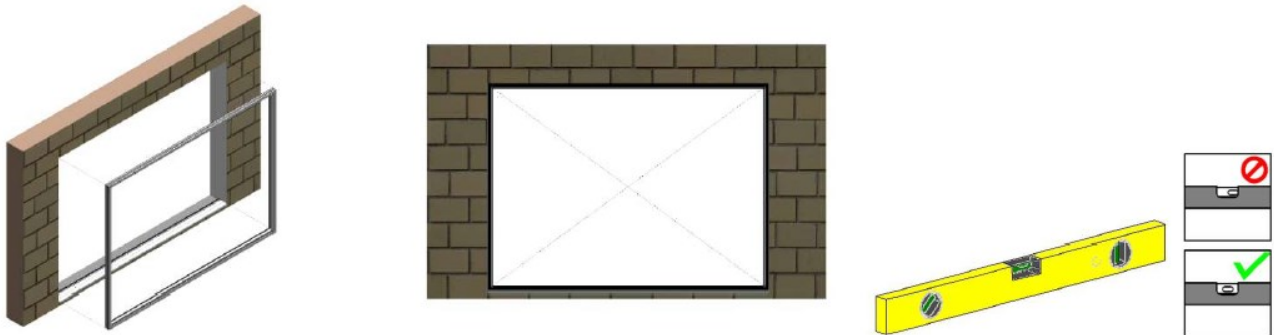

- Pack out all fixing points to ensure fixings are tight and fully supported.
- Secure the frame using suitable fixing anchors and plugs.

The heads of all screws which penetrate sub-cills, drainage trays or EPDM must be sealed using low modulus silicone and/or sealing washers to ensure water does not leak through into the sub-frame.

A = Anchor distance from corner of frame approximately 150mm.

B = Anchor spacing generally at maximum 300 mm.

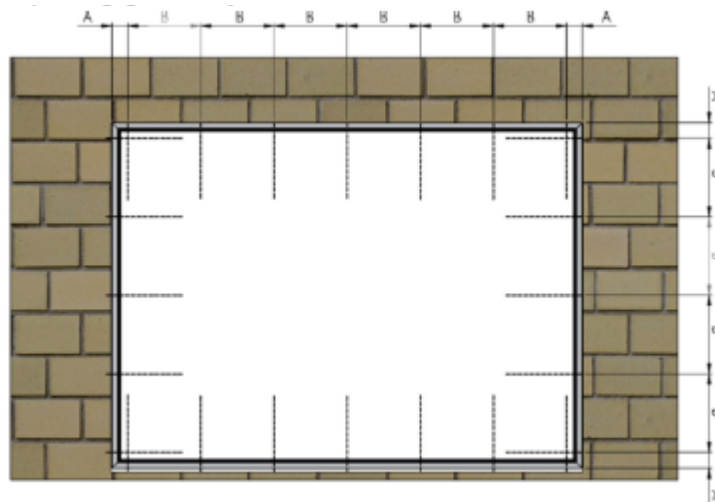

- Ensure the top and bottom frame remain plumb and square over the complete length.
- Using low modulus silicone ensure that the perimeter is sealed against water penetration on the inside and outside of the opening.
- Clean away all debris from the bottom track, particularly the stainless steel rail.

- Pack out all fixing points to ensure fixings are tight and fully supported.
- Secure the frame using suitable fixing anchors and plugs.

The heads of all screws which penetrate sub-cills, drainage trays or EPDM must be sealed using low modulus silicone and/or sealing washers to ensure water does not leak through into the sub-frame.

A = Anchor distance from corner of frame approximately 150mm.

B = Anchor spacing generally at maximum 300 mm.

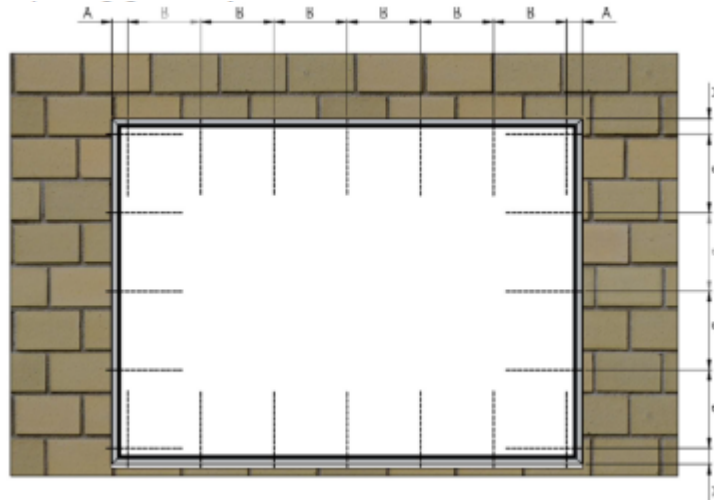

- Ensure the top and bottom frame remain plumb and square over the complete length.
- Using low modulus silicone ensure that the perimeter is sealed against water penetration on the inside and outside of the opening.
- Clean away all debris from the bottom track, particularly the stainless steel rail.

4. Door Sash Installation

a. Insert and adjust Sashes

Top Tip

- An easy way to identify where the sash needs to be installed is by looking at the bottom track and inspecting where the drainage holes are.

No Drainage in track = Internal side

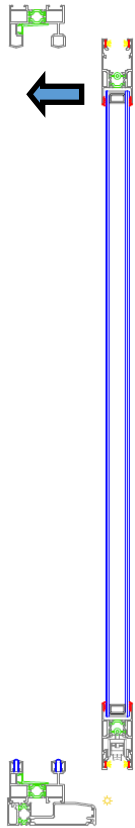

1. Offer up the pre-glazed sashes to the outer-frame

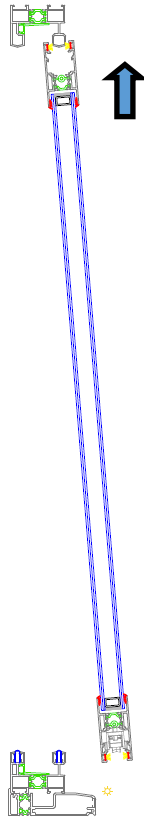

2. Pivot from base and Lift up into the top frame

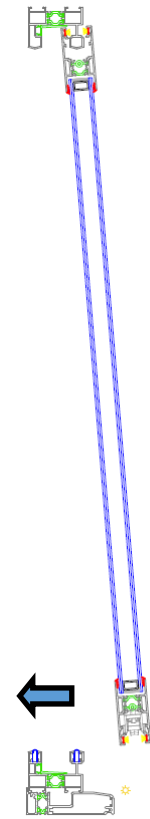

3. Lift up into the top track

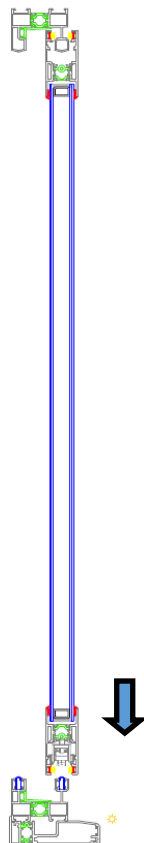

4. Push and pivot from the top to align with the bottom track.

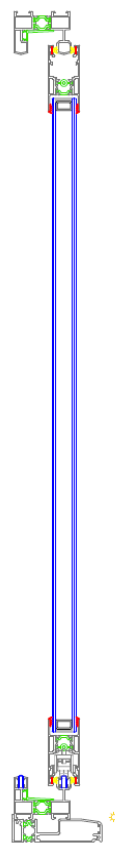

5. Drop the sash onto the base track, ensuring the rollers are correctly positioned on top of the stainless steel track

- Once the rollers are in the correct place, adjustment can be made at the base where the rollers are located. You'll need a torch to see the location of the rollers. You will also need a very long Allen key to get to the rollers.

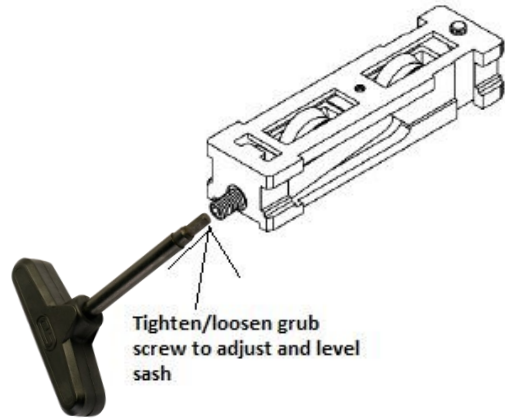
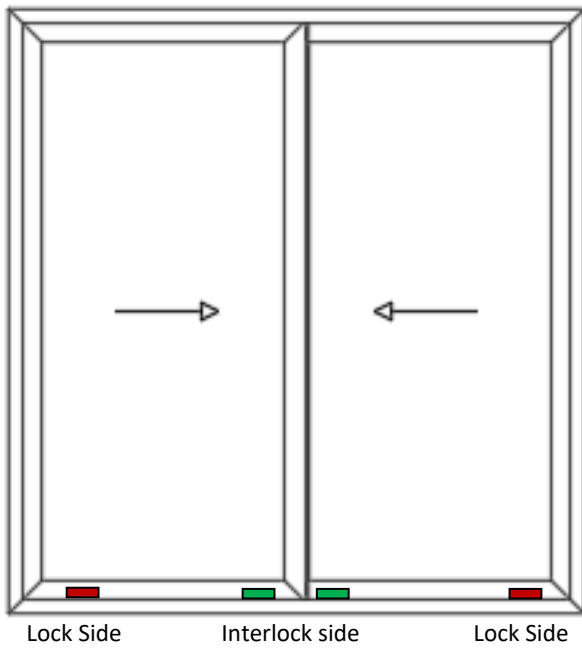

c. Sash buffers & Door stop

- Sash Buffers are fitted on the Locking side of the sash.
- Insert the buffer as seen below (highlighted in yellow) and fix into place top and bottom of sash.

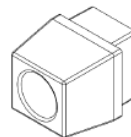
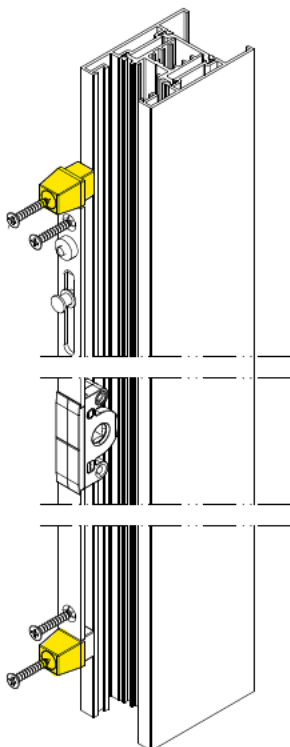

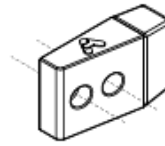
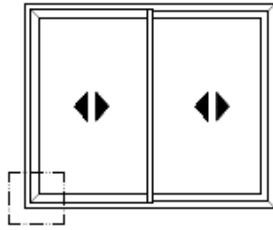

TOPE LIMITADOR
LIMITER CAP
264260

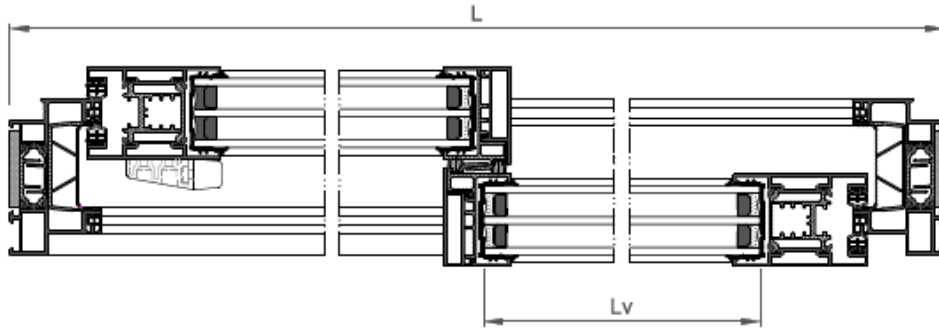

- Door stop top be fitted at the base to stop the

d. Lock Keeps and Anti-Lift

- The multipoint mushroom locks are pre-fitted to the sash.
- The keeps (blue box) will need to be fixed onto the outer frame in line with the lock so the mushroom head engage with the lock.

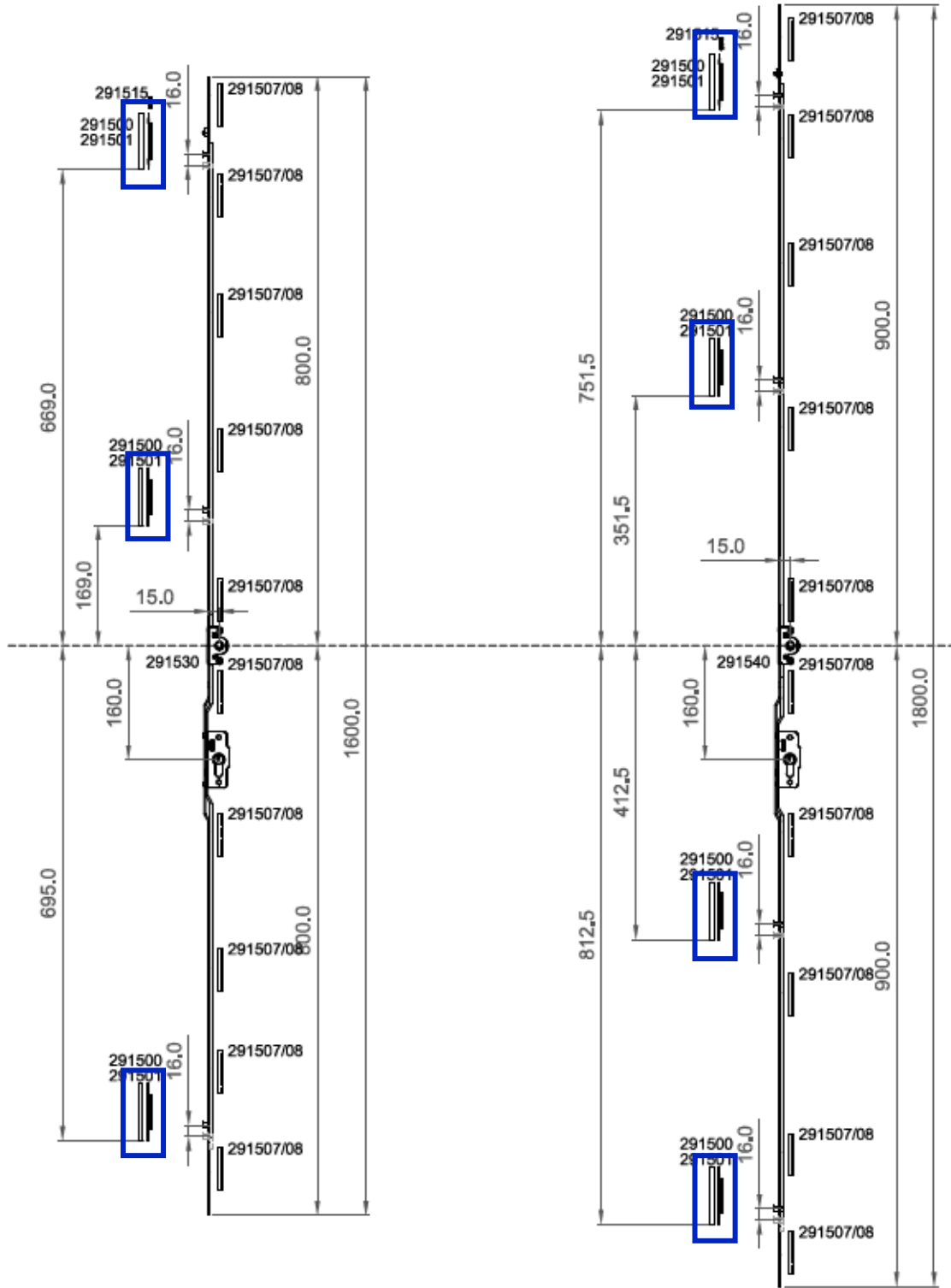

- When installing the keeps ensure the mushroom head are in alignment with the keeps so they engage and disengage correctly.

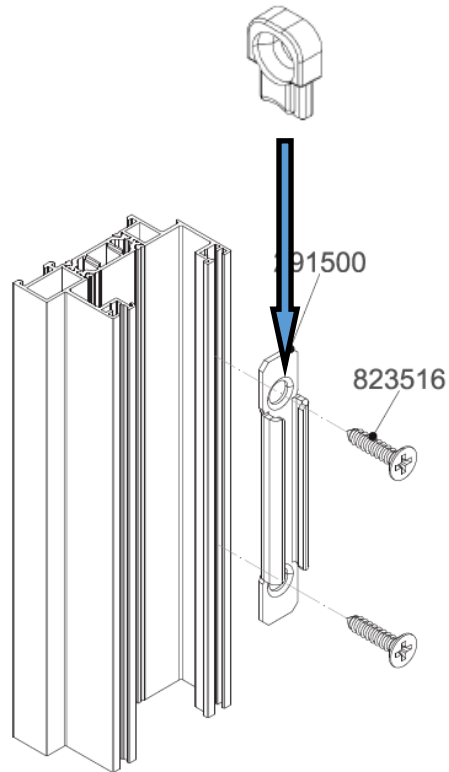

7.FINISHING TOUCHES

- Check that the handles and locking mechanisms operate smoothly on each door.
- Check the sliding action is smooth and free running.
- Check that the locks engage correctly when closed.
- Check caps are all present and that there are no screws missing.
- Check the weather seals and ensure that the doors are fully sealed with no visible gaps.
- Clean the bottom track and ensure it is free of any debris.
- Ensure that the homeowner is instructed and knows exactly how to use and look after minimal sliding doors.

8.OPERATION AND MAINTENANCE**a. Opening and closing operation for minimal sliding doors**

To open doors

- Unlock the door by turning the key
- Release the locking mechanism by rotating the handle upwards.
- Pull the door open using the handle.
- Middle sliding panes will stack and slide with the adjacent panes. They do not have independent locks or handles.

To close doors

- Pull the door closed using the handle. Ensure the sash is pushed tight against the frame.
- Engage the locking mechanism rotating the handle downwards.
- Lock the door by turning the key.

b. Maintenance

- Ensure top and bottom tracks are kept clean and free of any debris or foreign objects that can stop the function of the sliding door.
- Ensure all door locking mechanisms are kept clean and any moving parts are regularly lubricated with light machine oil at least once a year.
- Powder coated aluminium profiles should be cleaned with warm water and mild household detergent at least once a year.